

S-1140/S-1240 Resilient seat gate valve DN 65

DIN F4 short/DIN F5 long

02-13/103900011/01.2007 **2**
Page 1 of 2

Application and features

- Application: Water and sewage
- Wedge in EPDM-rubber approved for drinking water
- Design pressure 64 bar
- Clockwise closing



Technical description

- Approvals: See separate sheet [\[Approvals\]](#)
- Standards: DIN 3352-1/4, DIN 3840, EN 545, EN 12266, ISO 7259, EN 1074, EN 1171
- Face-to-face length S-1140: EN558/ ISO 5752 series 14
- Face-to-face length S-1240: EN558/ ISO 5752 series 15
- Max. working pressure: PN 16, vacuum -0,8 bar
- Flange drilling: PN 10/16 (EN1092-2)
- Max. temperature: 60°C
- Test pressure open valve: 24 bar
- Test pressure closed valve: 21 bar
- Coating: Epoxy minimum 250 µm
- Product colour: Blue, RAL 5017
- Body/bonnet connection: Socket head bolts covered with wax
- Stem: Non-rising with tapered stem end, according to DIN 87304 (see table)

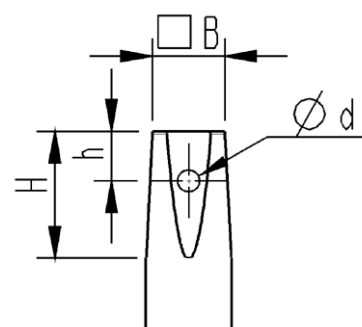

Dimensions stem top:

DN	B	H	h	d
65	17,3	34	17	7

References, dimensions and performances

Series	DN mm	H mm	L mm	Weight kg	Kv m ³ /h	Z	Esco no.	NRF no.	Danfoss no.
S-1140	65	262	170	11,5	374	0,2	11400065	550 6029	149L204600
S-1240	65	262	270	12	374	0,2	12400065	550 5406	149L205000

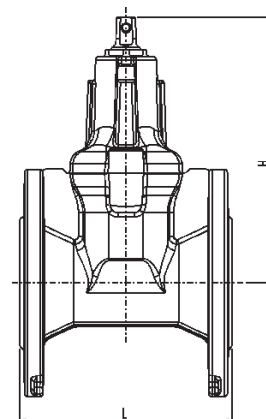

Kongsberg Esco AS can accept no responsibility for possible errors in catalogues, brochures and other printed material. Kongsberg Esco AS reserves the right to alter its products without notice. This also applies to products already on order provided that such alterations can be made without subsequent changes being necessary in specifications already agreed. All trademarks in this material are property of the respective companies. Kongsberg Esco and the Kongsberg Esco logotype are trademarks of Kongsberg Esco AS. All rights reserved.

S-1140/S-1240 Resilient seat gate valve DN 65

DIN F4 short/DIN F5 long

02-13/103900011/01.2007 **2**
Page 2 of 2

Material specification

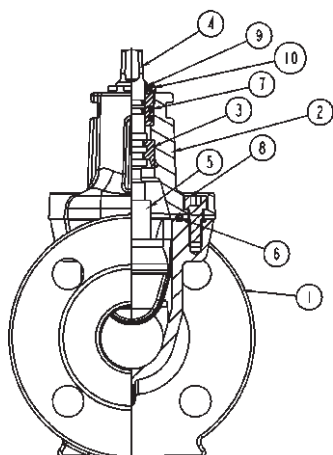

Pos	Detail	Materials
1	Body	Ductile iron EN 1563 EN-GJS-500-7
2	Bonnet	Ductile iron EN 1563 EN-GJS-500-7
3	Bushing	Dezinkfree brass (DZR)
4	Stem	Stainless steel EN 10088-3 1.4021
5	Wedge	Dezinkfree brass (DZR) with rubber lining (EPDM)
6	Gasket	Rubber approved for drinking water
7	O-rings	Rubber approved for drinking water
8	Socket-head bolts	Steel 8.8
9	Dirt seal	Rubber (NBR)
10	Stuffing box	Dezinkfree brass (DZR)

Installation

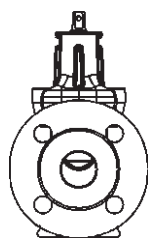

Recommended

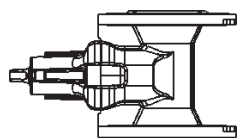

Possible

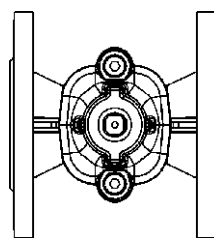

Possible

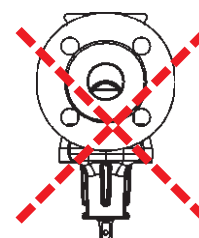

Not recommended

Accessories and other variants

Accessories:

- S-1120/S-1121 Norwegian cap
- S-1110 Handwheel
- S-1880 Spindle extension
- S-1880-0 Operating tool bar
- S-1830/S-1835/S-1840 Operating box
- S-1890 Sleeve for S-1140 DN 65

Other variants:

- S-1140/S-1240 Clockwise closing DN 40-50
- S-1140/S-1240 Clockwise closing DN 80-150
- S-1140/S-1240 Clockwise closing DN 200-300
- S-1140/S-1240 Clockwise closing DN 400/400-500